

40024610

Instructions de montage originales  
Original mounting instruction

17/08/21  
08/17/21

PVA  
PVA

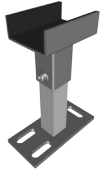
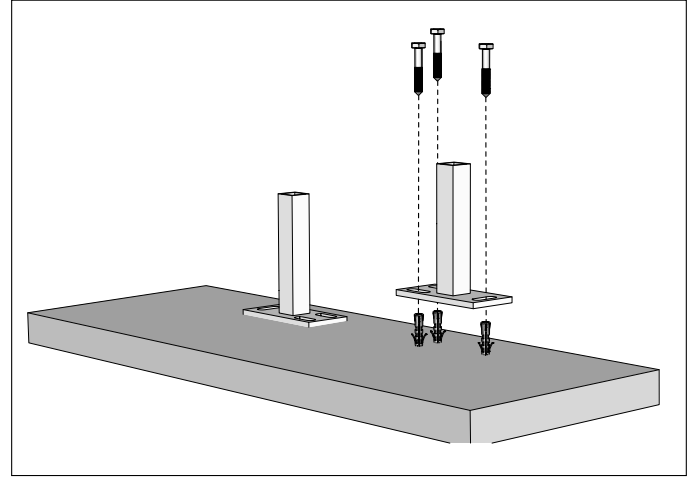
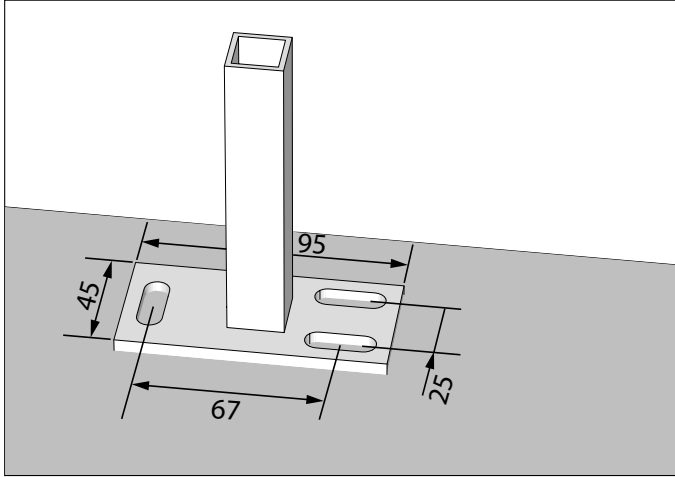
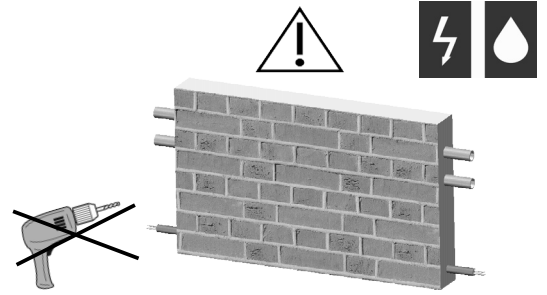
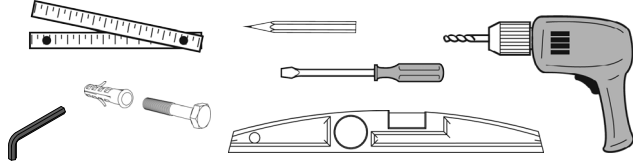

**KPV**

Blanc	109051
Couleur	109059
Fixation murale CVD obligatoire	

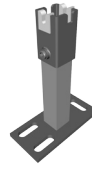

**KPH**

Blanc	108051
Couleur	108059
Fixation murale CVD obligatoire	

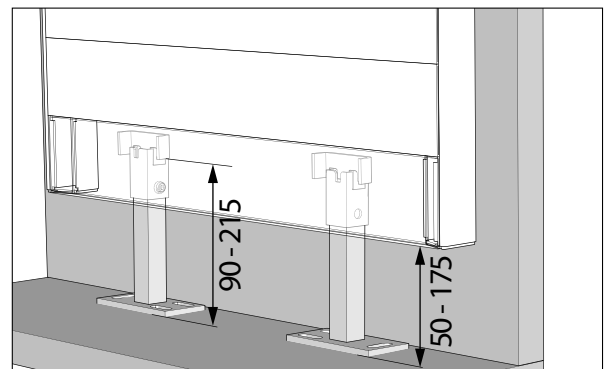
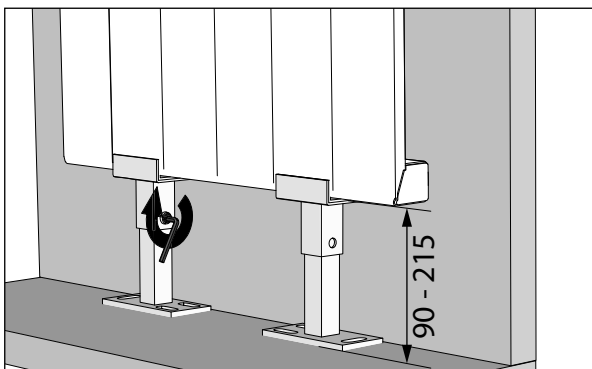
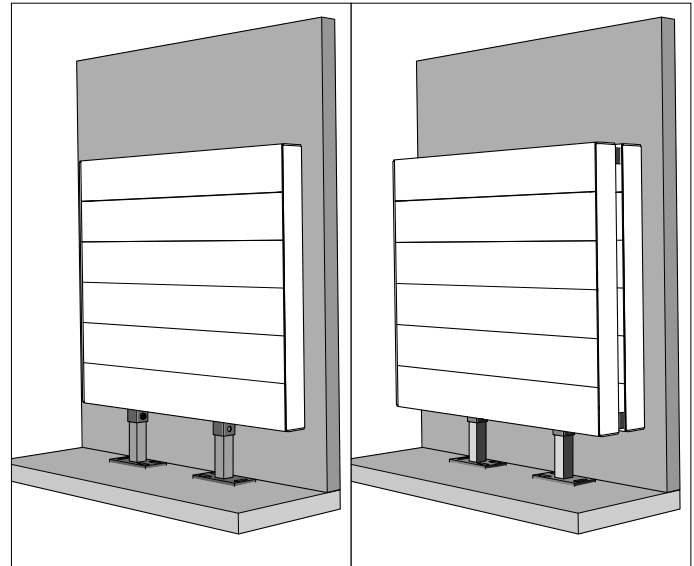
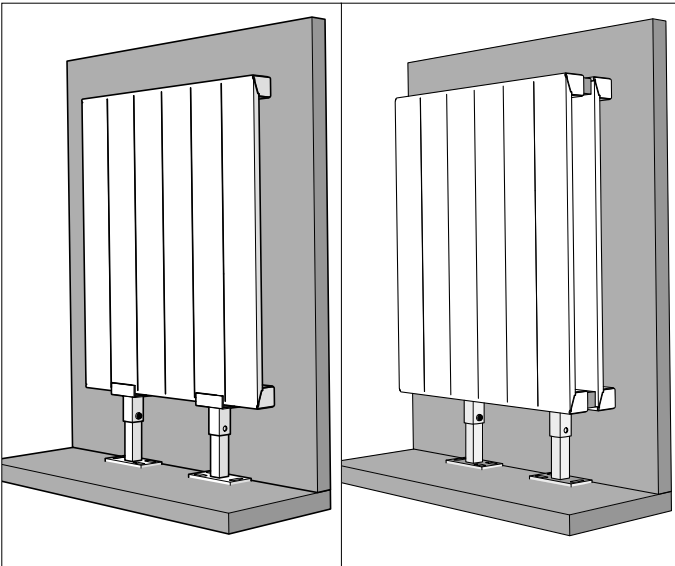

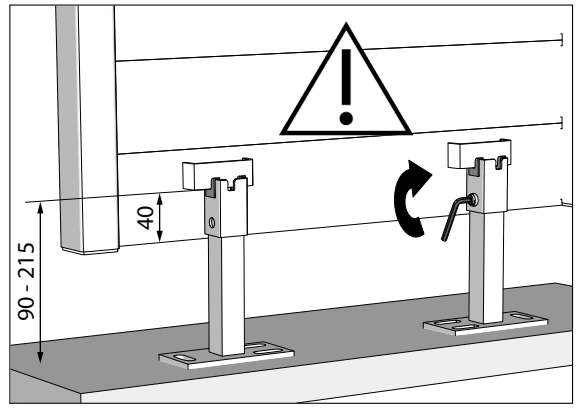

### Option WFV115 à la commande :

[ Fixation murale CVD obligatoire si hauteur appareil > 630 mm ]

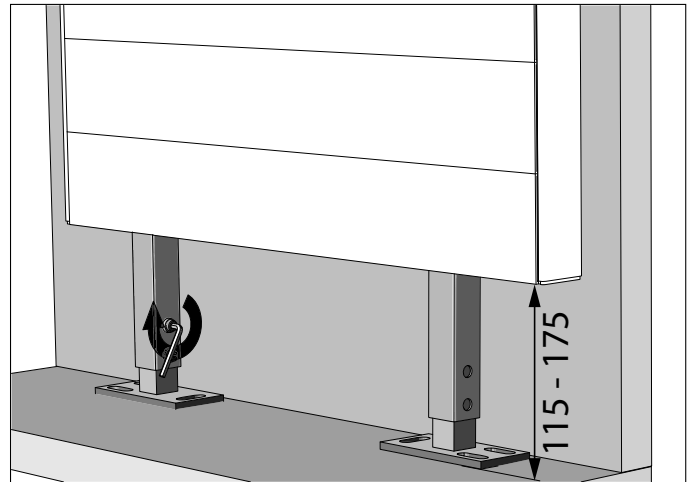
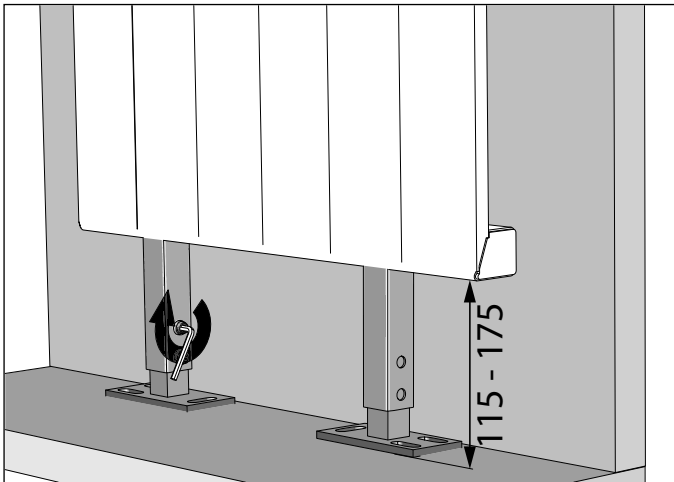

### Option :

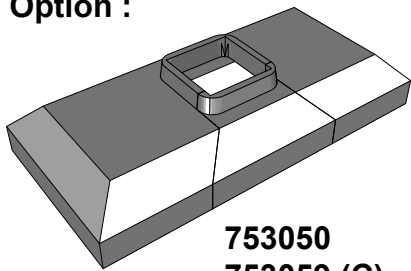

753050  
753059 (C)

