



40016612

Original mounting instruction

13/12/21

PVA

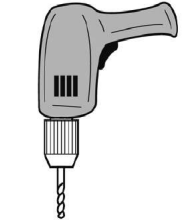
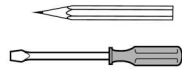
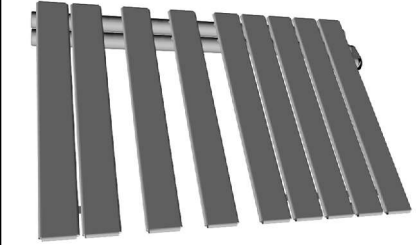
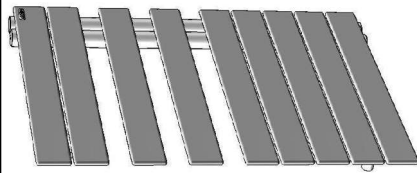
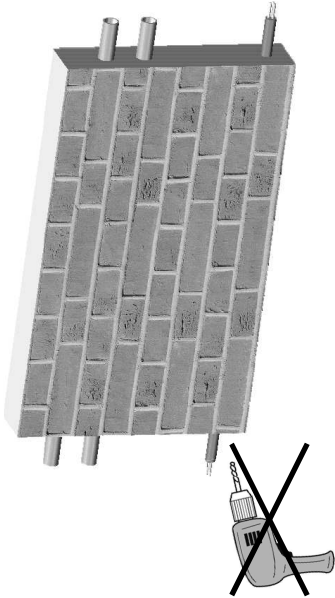
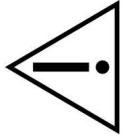

MISE EN GARDE : Pour éviter tout danger pour les très jeunes enfants, il est recommandé d'installer cet appareil de façon telle que le barreau chauffant le plus bas soit au moins à 600 mm au dessus du sol.

CAUTION To avoid any danger to very young children, you are advised to install this appliance so that the lowest heating bar is at least 600 mm off the floor.

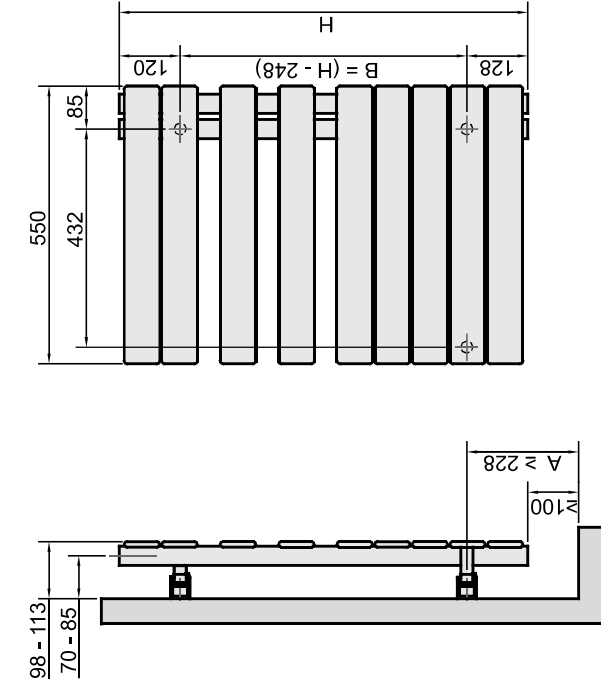

3024	H (mm)	A (mm)	B (mm)	P (kg)
0020 (C)	805	≥ 301	534	15,30
0030 (C)	1183	≥ 301	912	21,30
0040 (C)	1676	≥ 301	1405	28,90

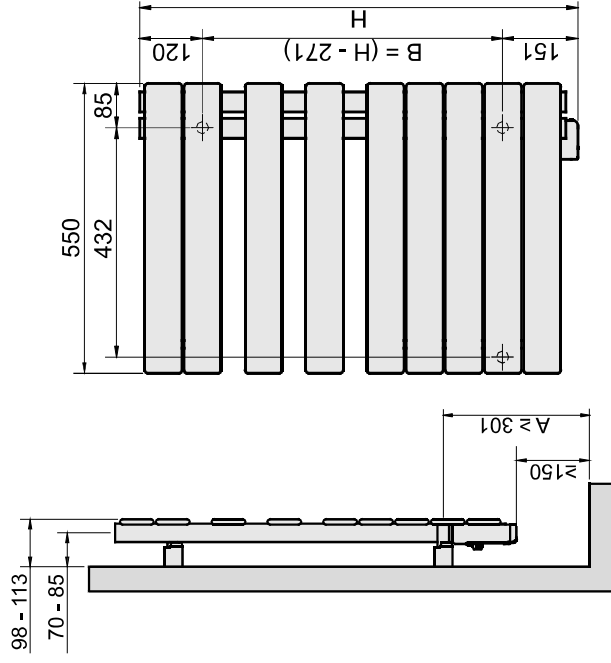

1012	H (mm)	A (mm)	B (mm)	P (kg)
0020 (C)	805	≥ 228	935	14,50
0030 (C)	1183	≥ 228	1428	20,00

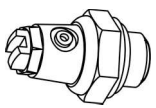

Purgeur à jet orientable

Serrez modérément le purgeur sur le radiateur pour faire étanchéité à l'aide du joint torique (15 Nm max).
Desserrez le pointeau et tournez le cône pour diriger le jet comme vous le souhaitez.

Swivelling air bleed valve

Tighten the bleed valve moderately on the radiator with the o-ring to ensure watertightness (15 Nm max).
Loosen the needle valve and turn the cone to direct the jet in the required direction.

This steel radiator is suitable for connection to the central heating system only.
When new or additional radiators are being installed, the system should be drained, cleaned and flushed in accordance with BS7593 and a good quality inhibitor, suitable for mixed metal systems, used to protect the system.
If in doubt, seek professional advice.

(For information on water treatment, please call the Water Treatment helpline on 01799 521133)

